

**ZUSÄTZLICHE ÜBUNGEN BAUSTATIK I – SERIE I**

**1. Der einfache Balken**

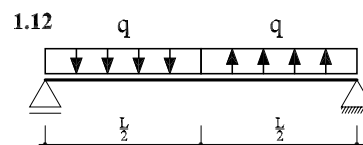

1.13

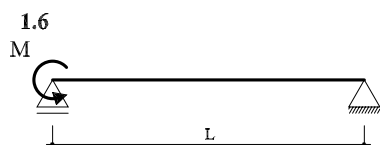
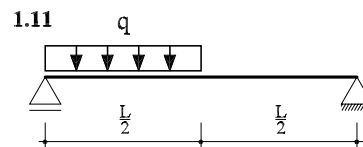
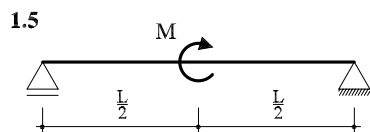
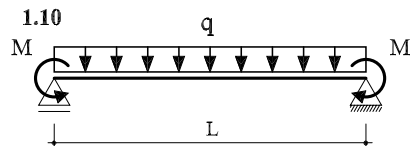
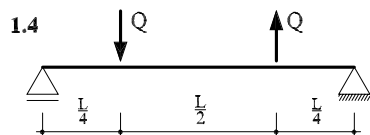
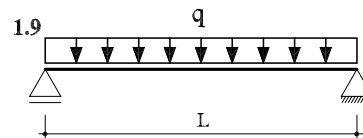
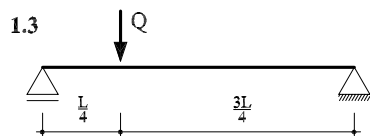
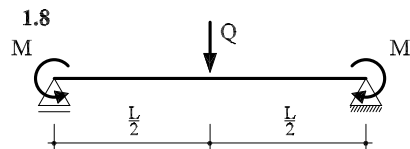
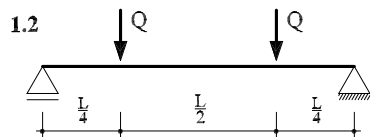
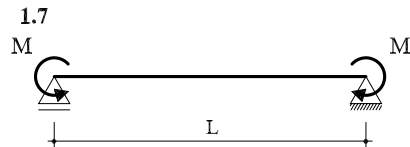
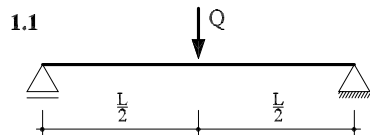
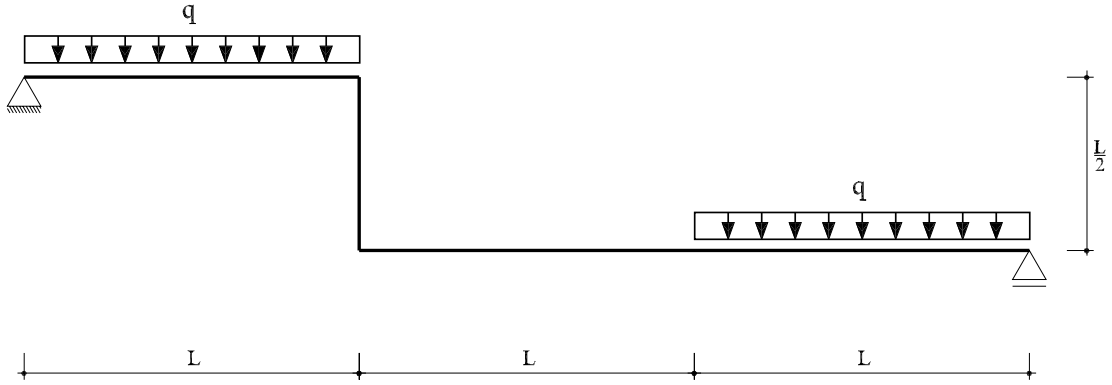

1.14

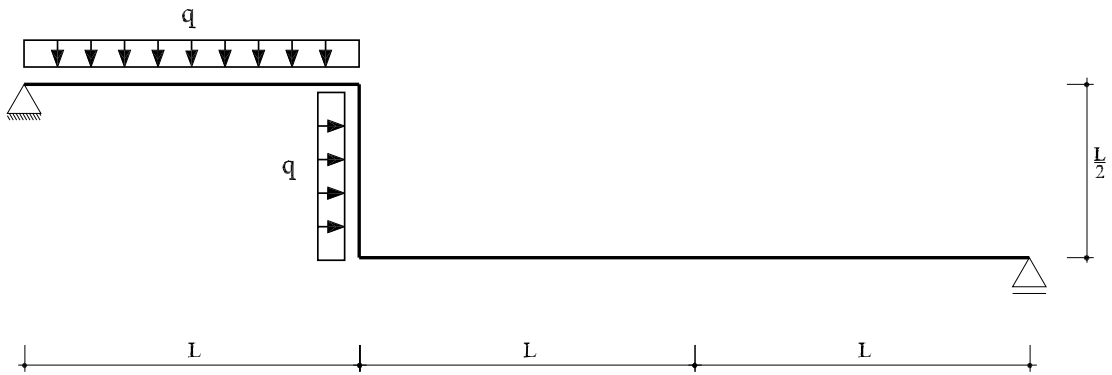

1.15

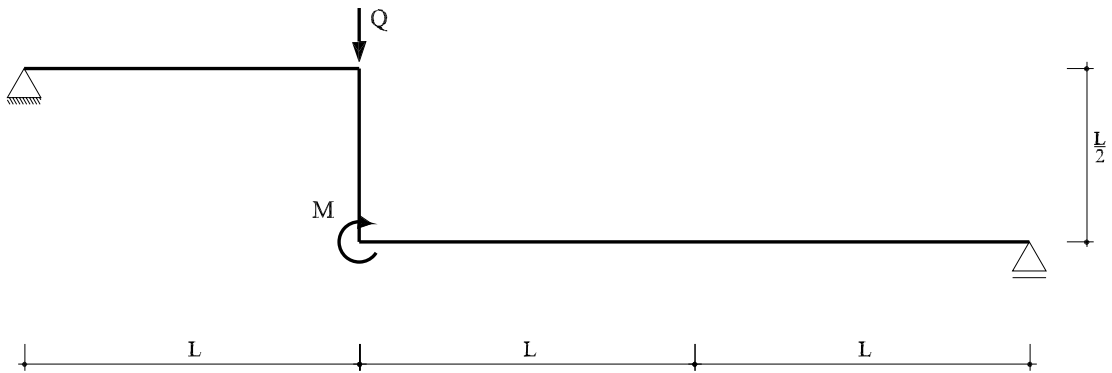

1.16

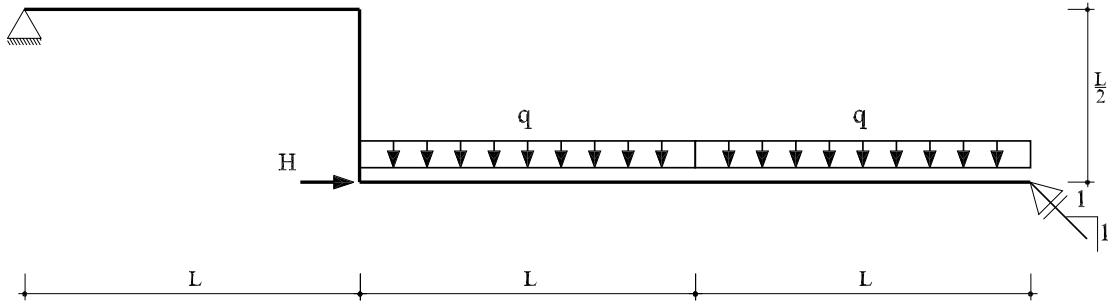

1.17

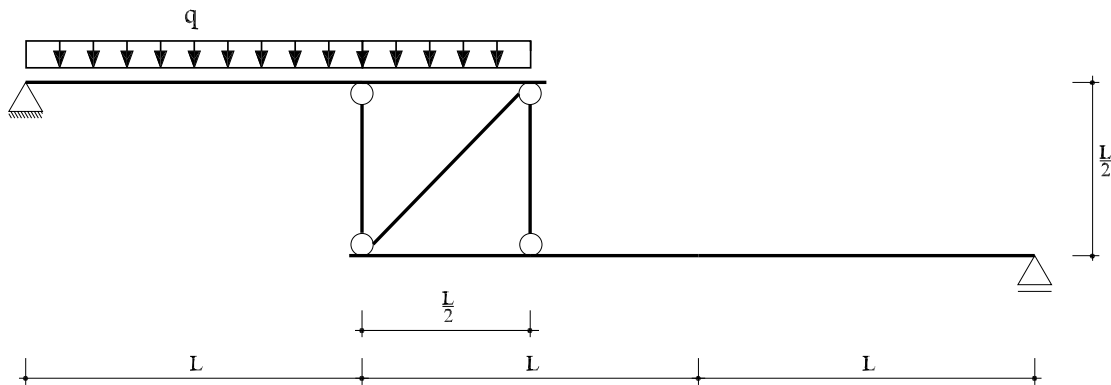

**2. Der schräge einfache Balken**

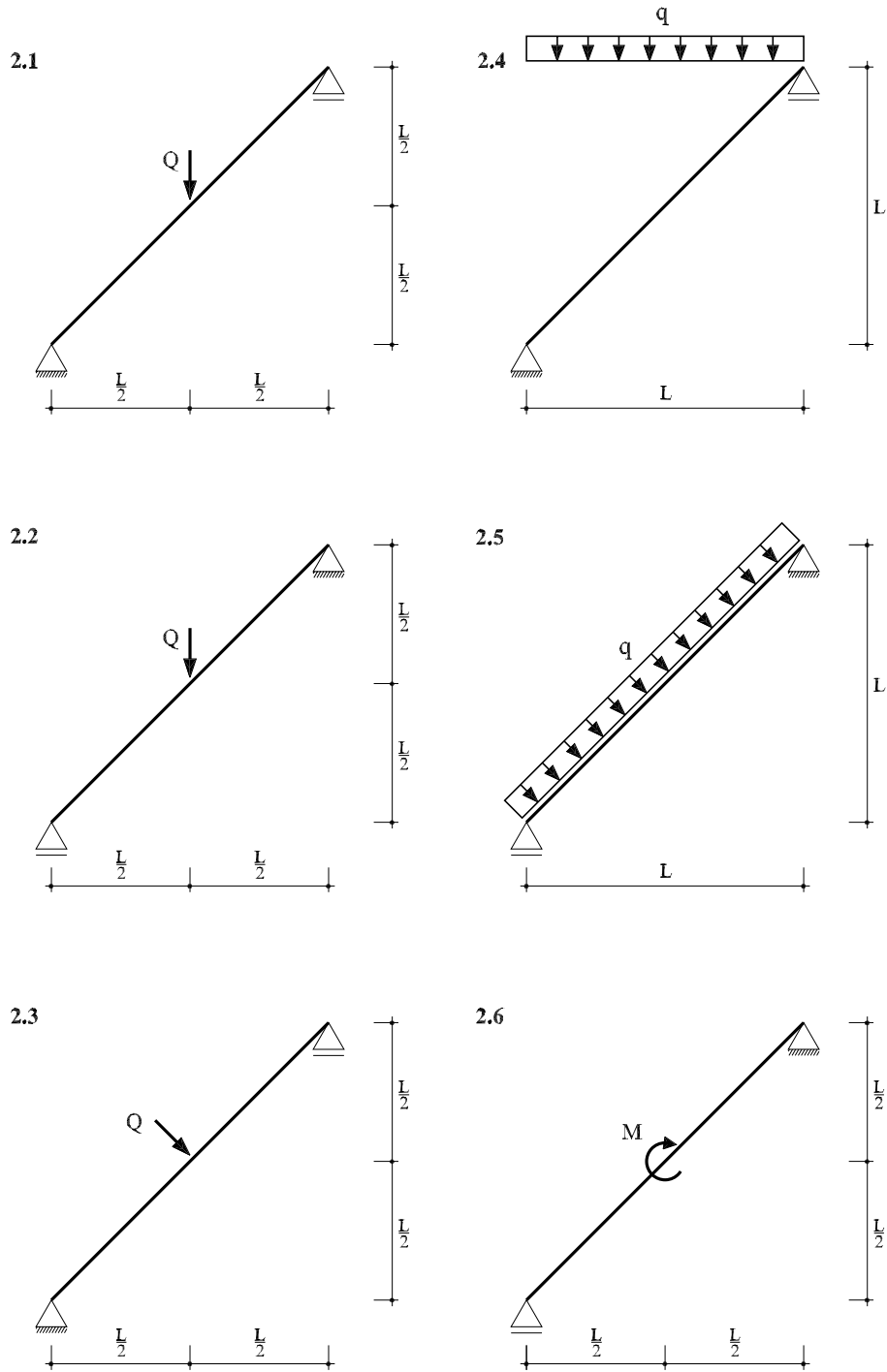

**3. Der einfache Dachbalken**

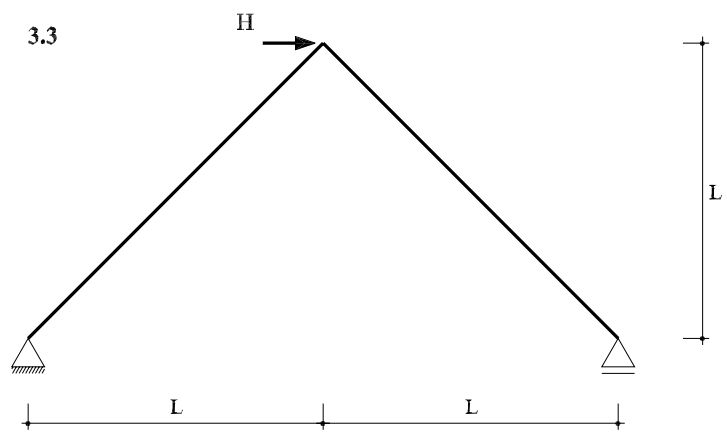
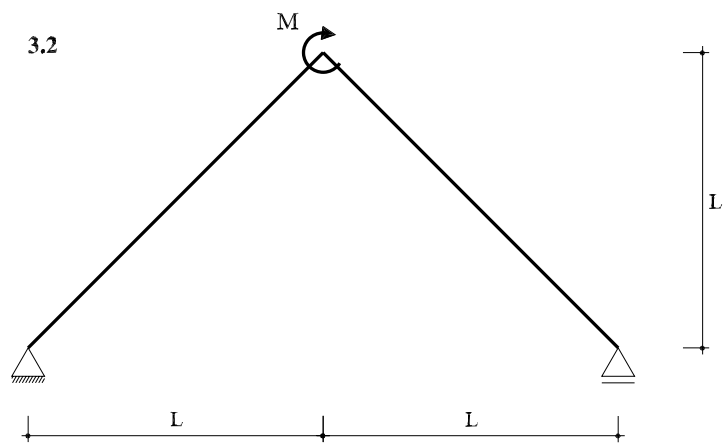
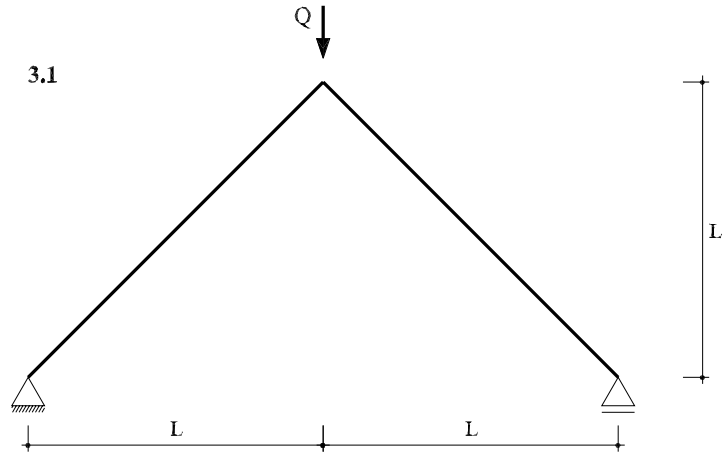

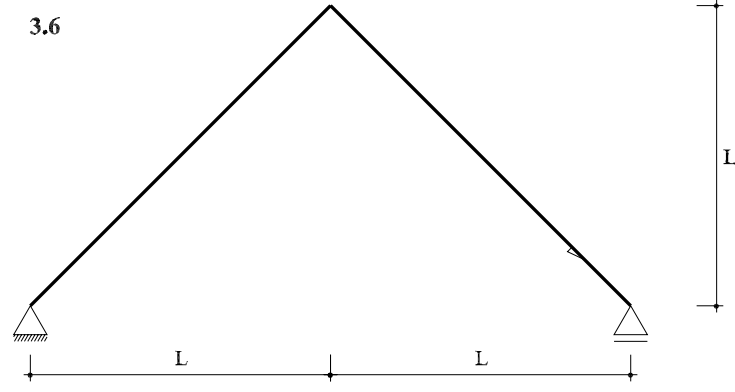
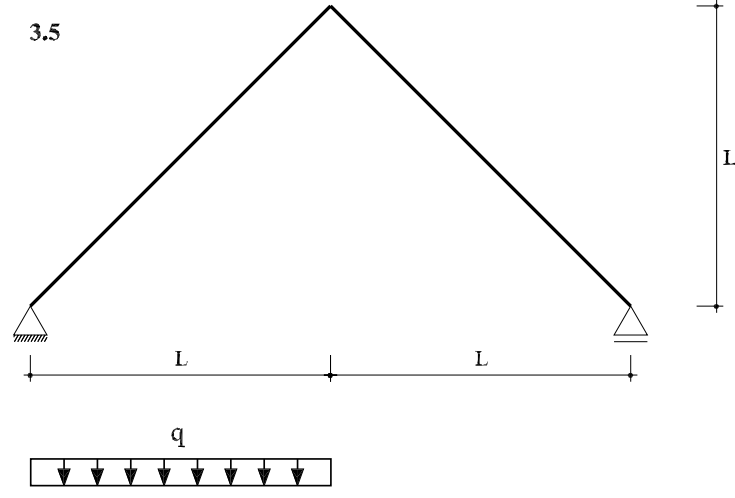
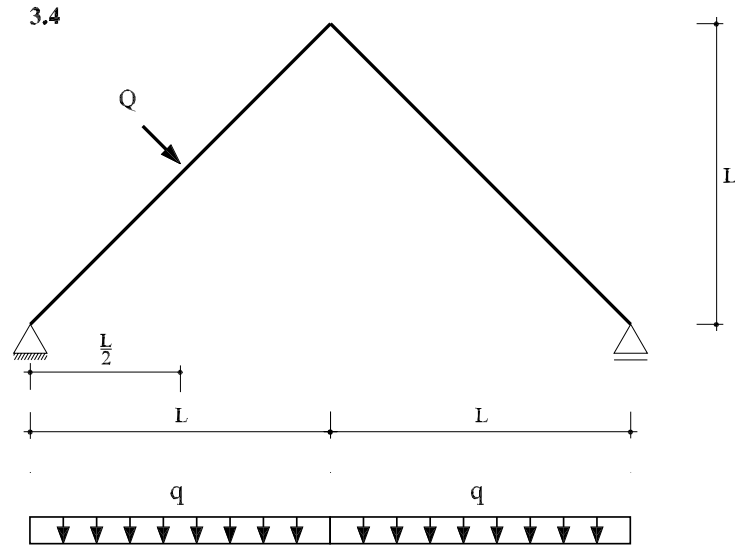

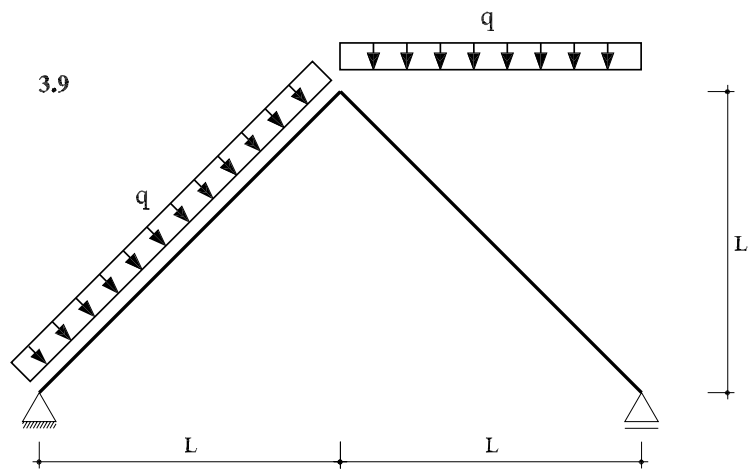
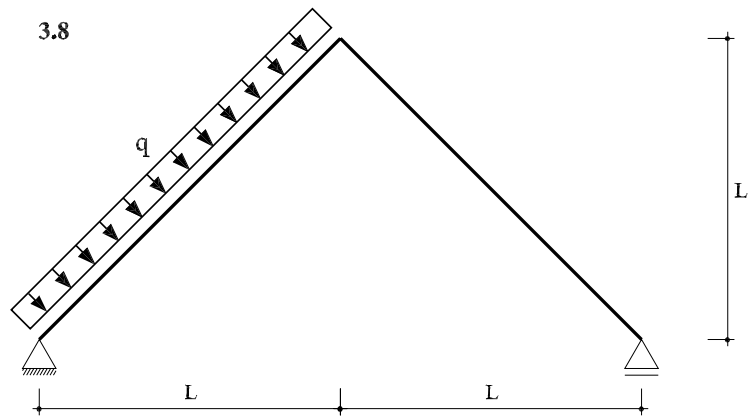
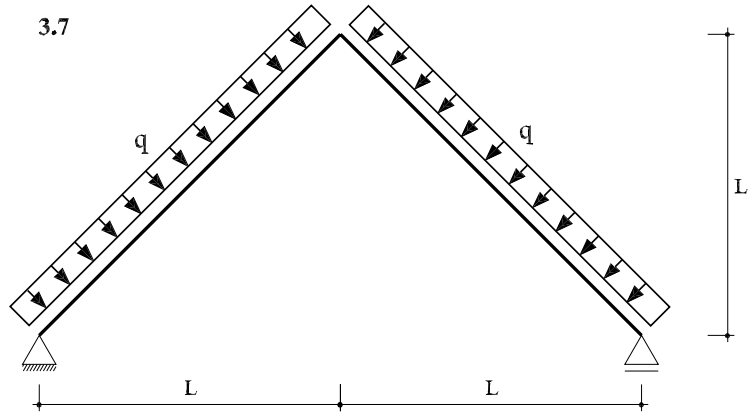

**4. Der Gerberträger**

**4.1**

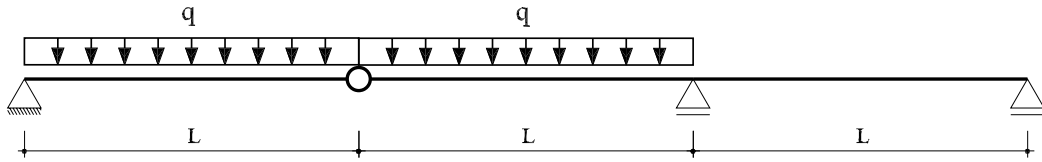

**4.2**

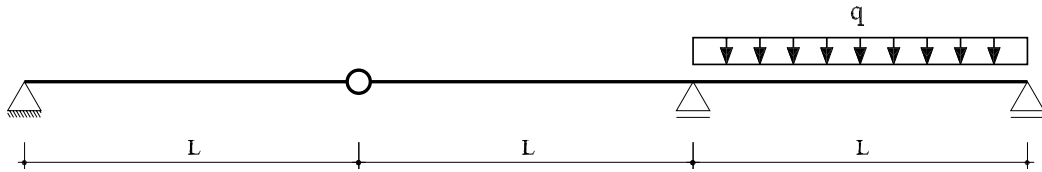

**4.3**

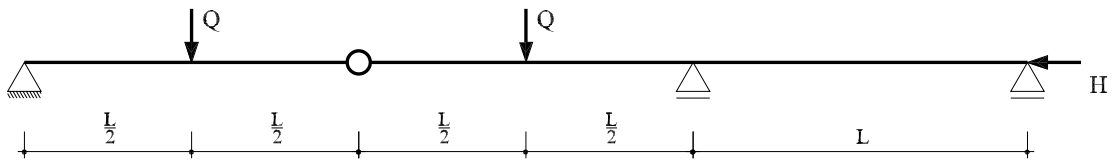



4.4

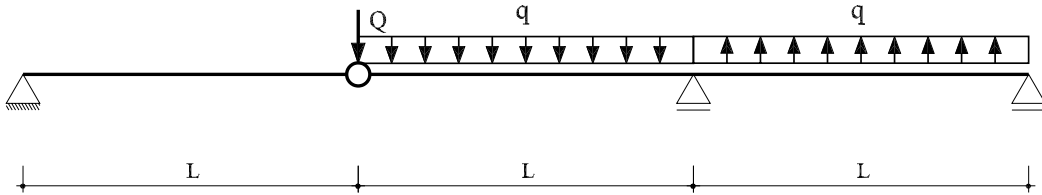

4.5

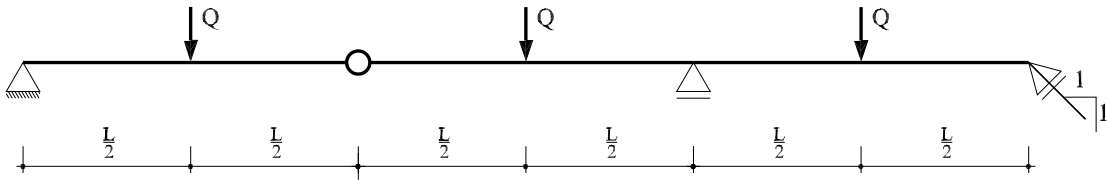

4.6

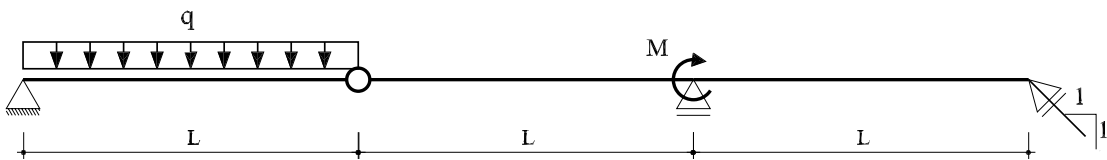

4.7

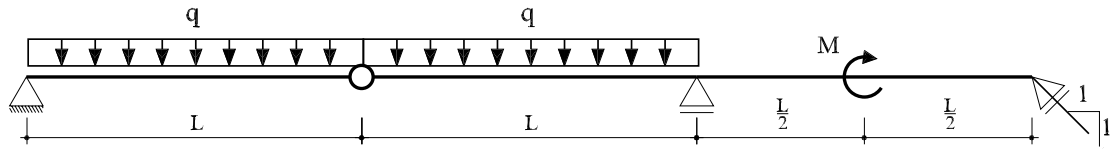

4.8

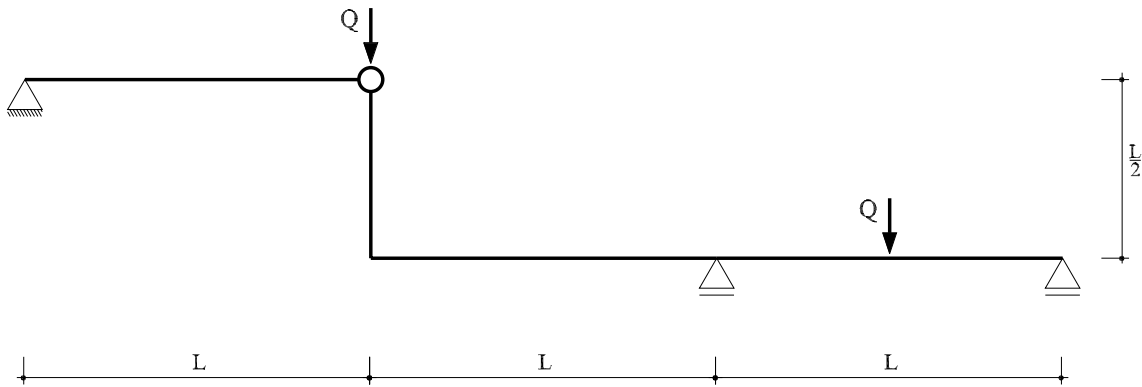

4.9

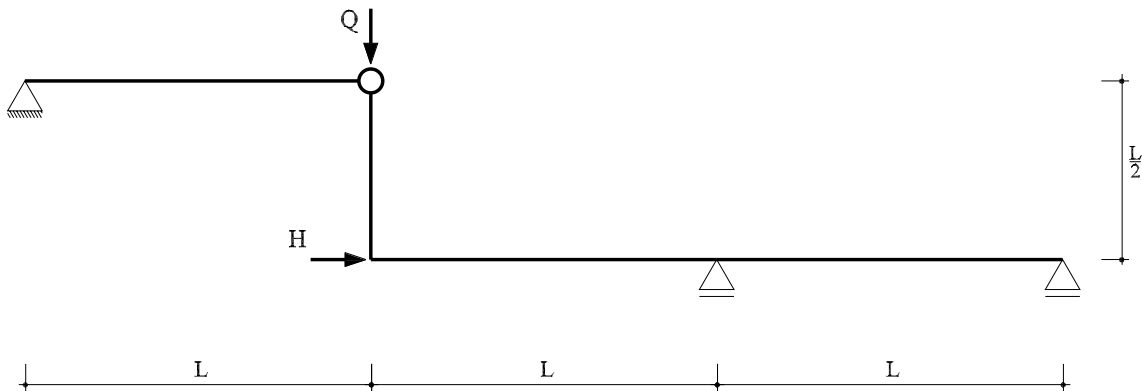

4.10

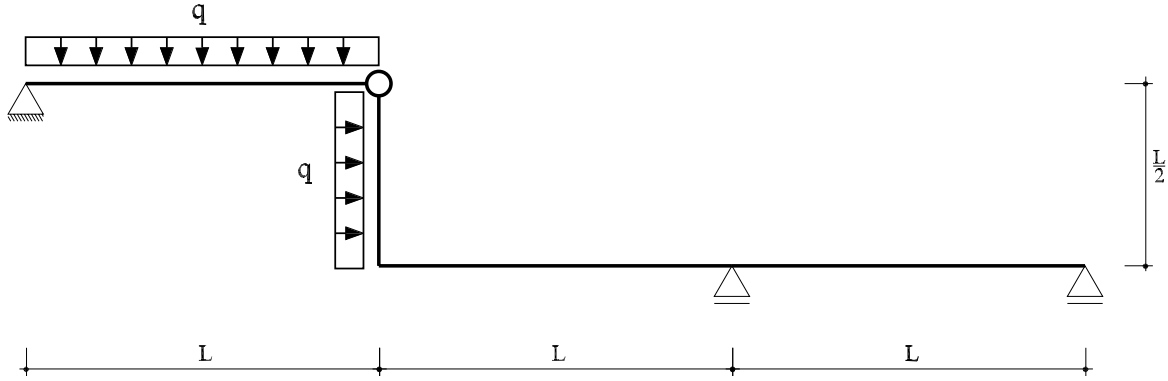

4.11

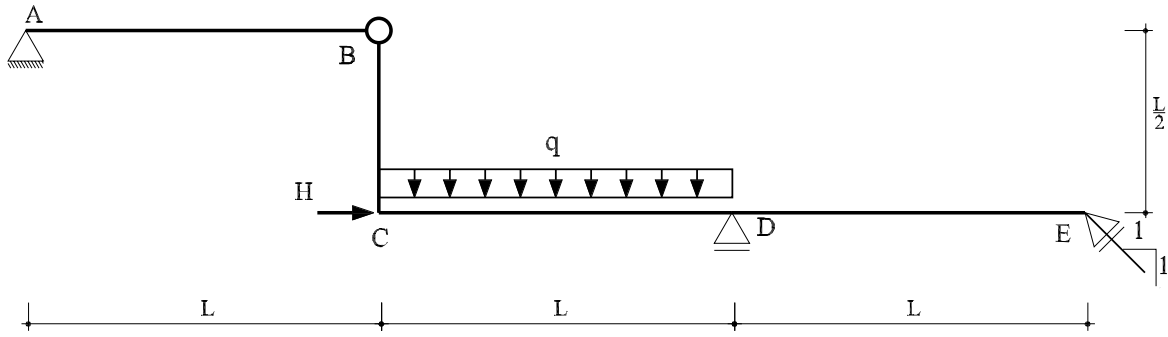

4.12

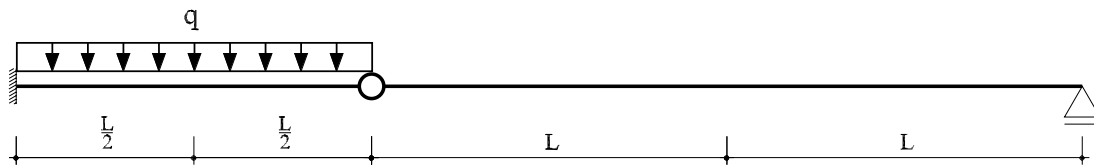

┌

4.13

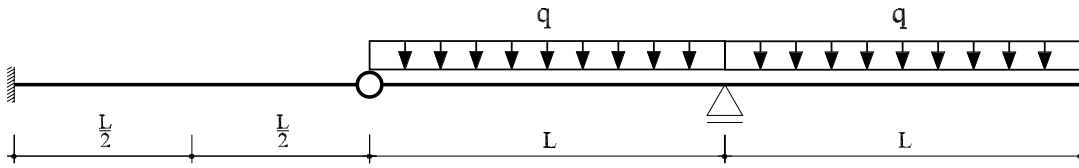

4.14

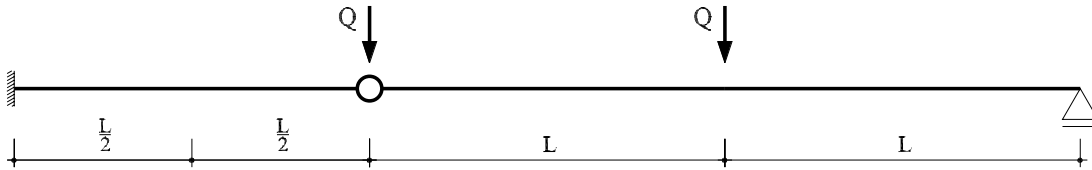

□

**5. Der statisch bestimmte Rahmen**

5.1

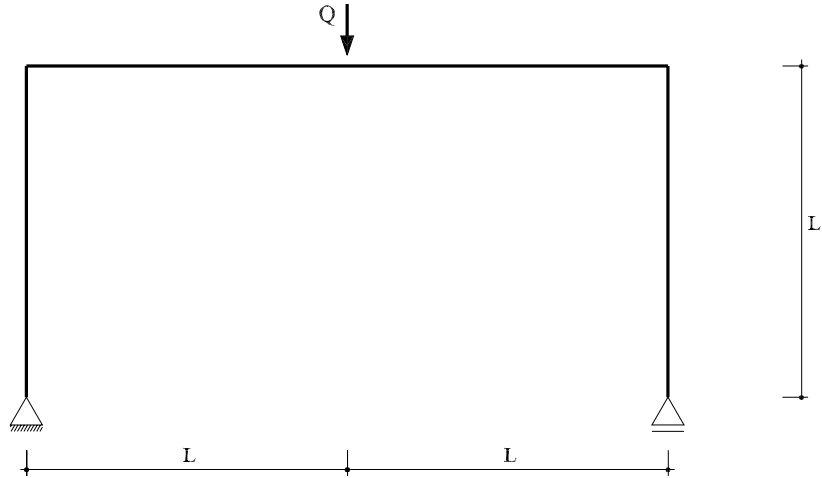

5.2

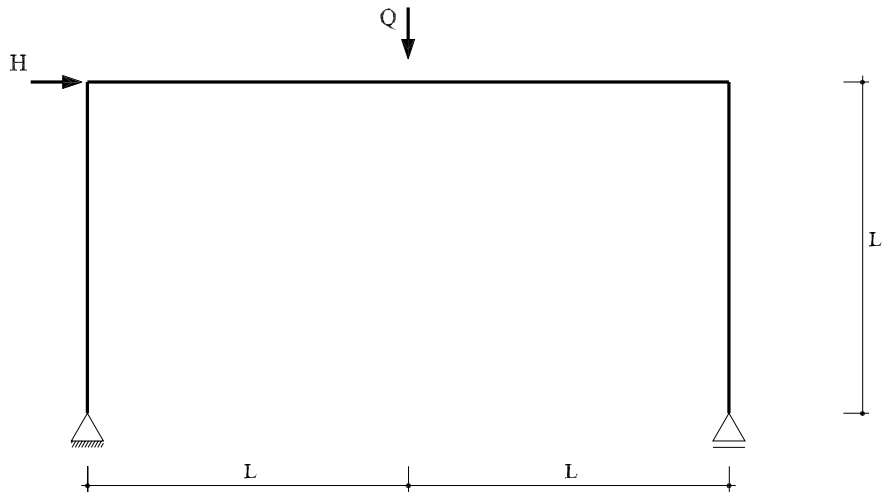

5.3

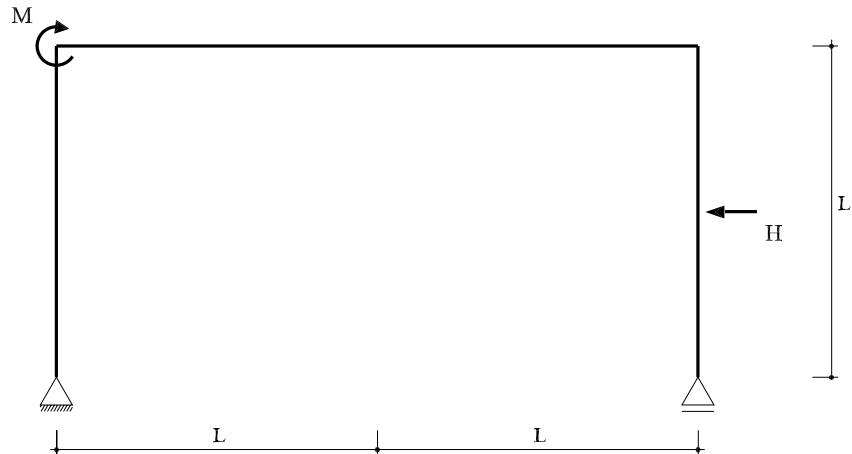

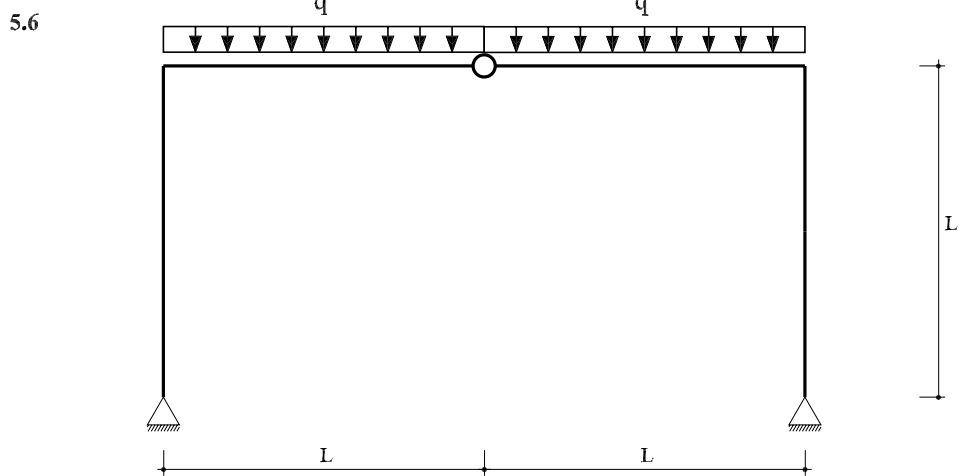
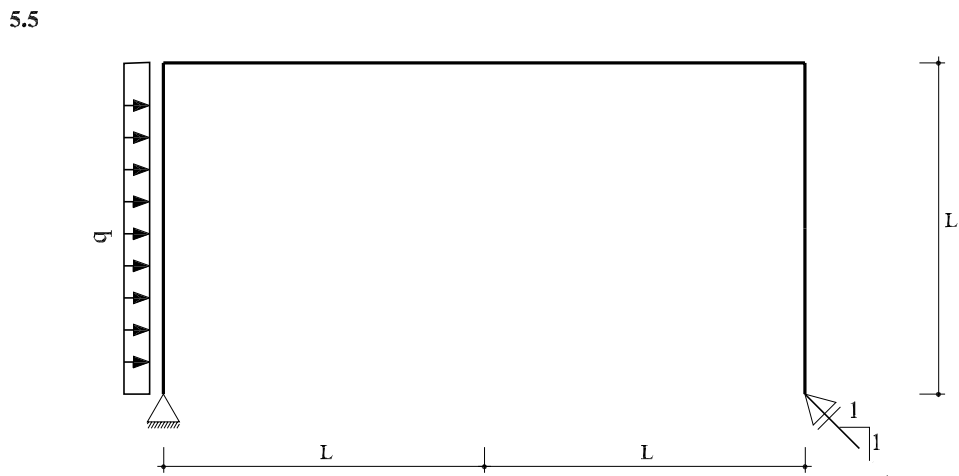
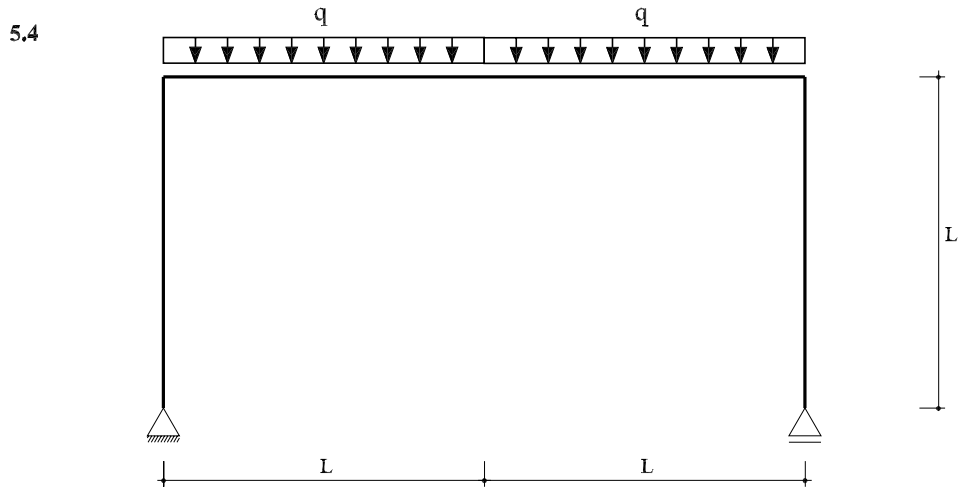

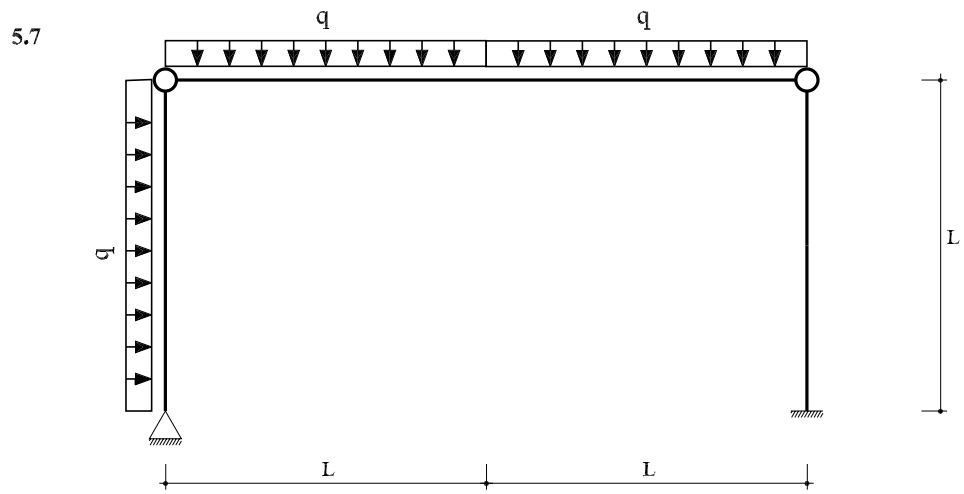

**6. Der statisch bestimmte Stabzweischlag**

6.1

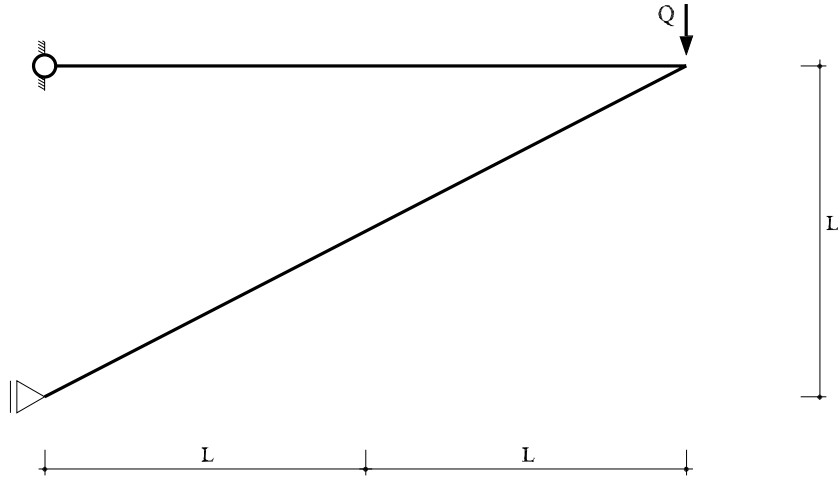

6.2

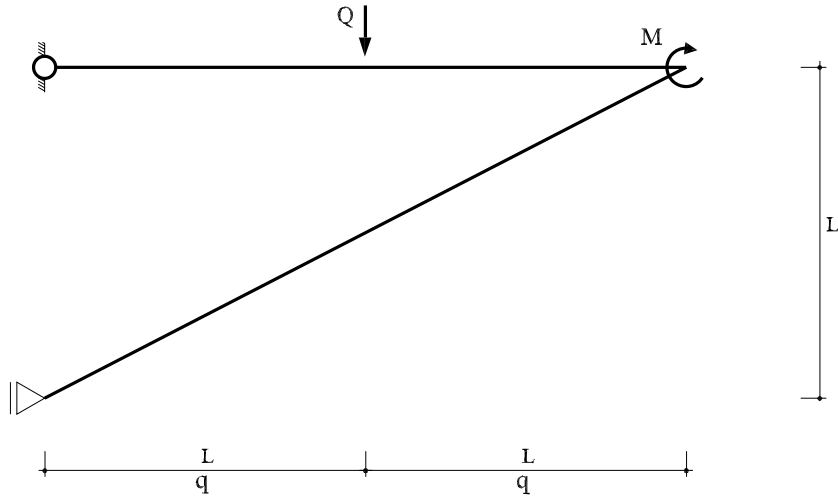

6.3

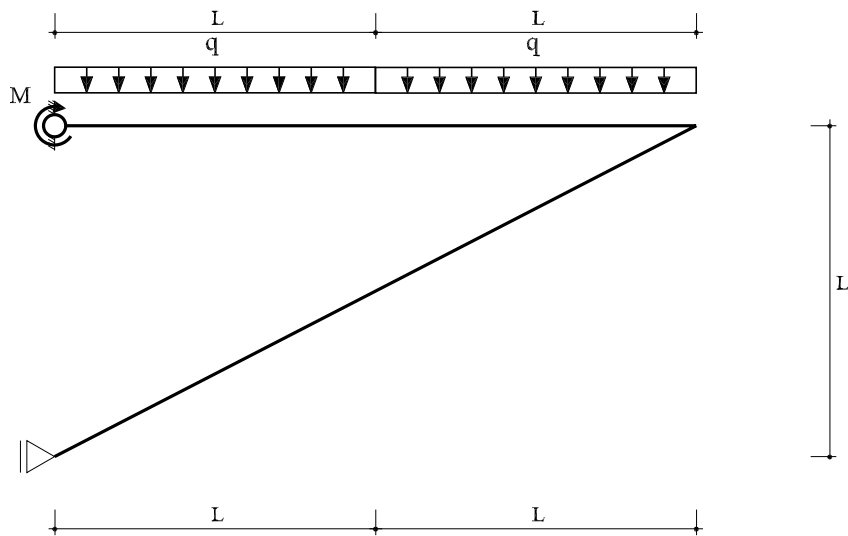



6.4

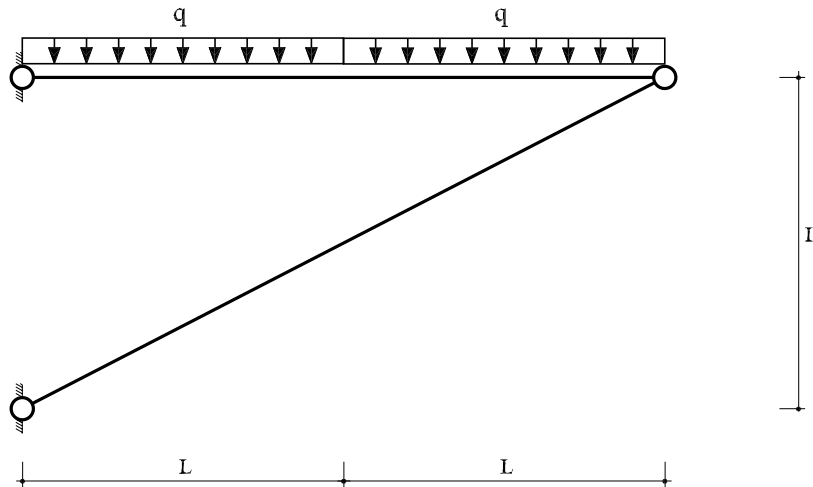

6.5

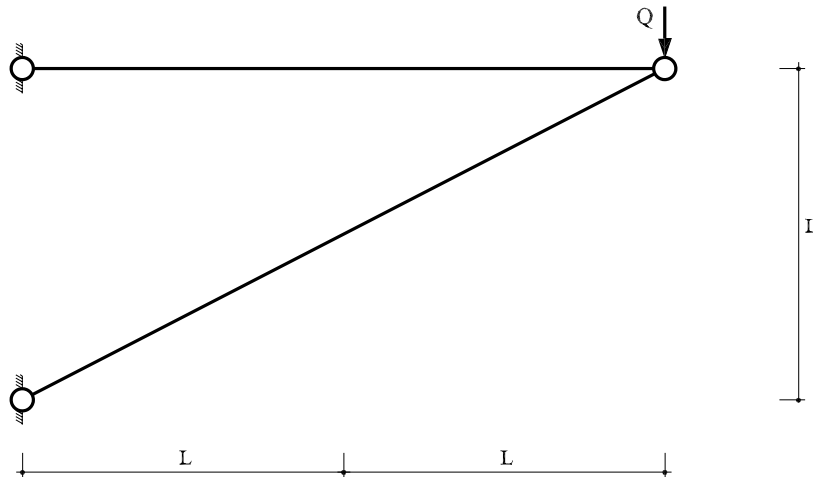

6.6

