

1) M:

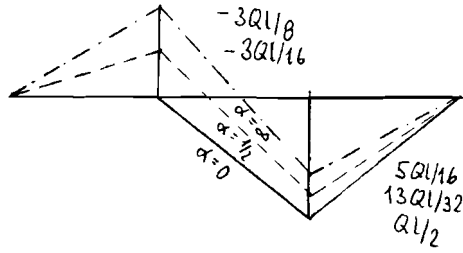

2) M:

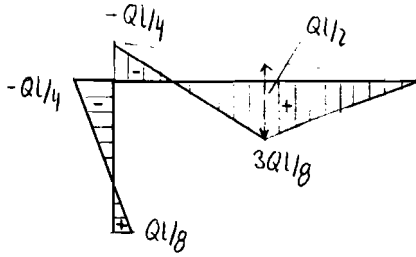

N:

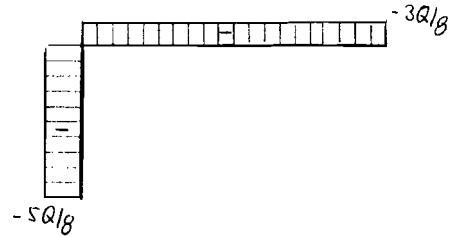

V:

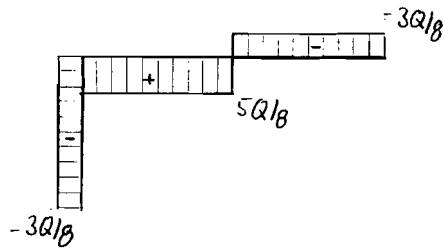

3) M:

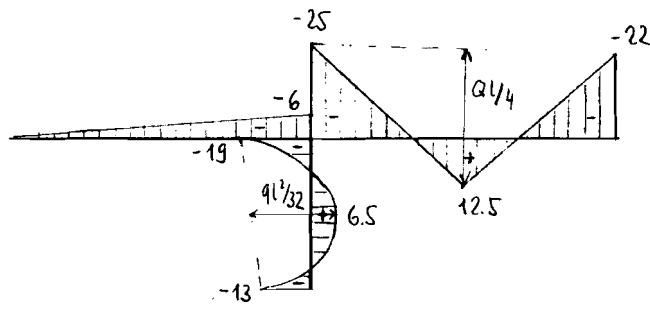

$$[ql^2/720] = [ql/144]$$

V:

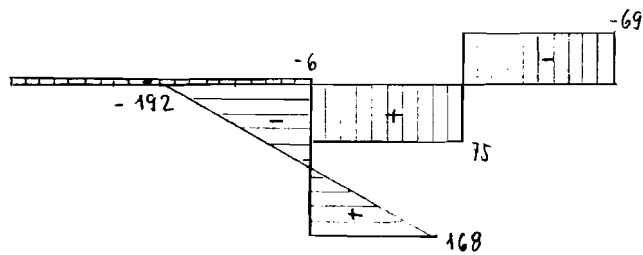

$$[ql/720] = [ql/144]$$

N:

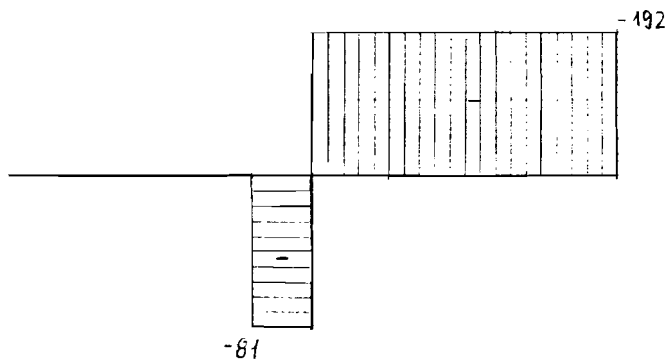

$$[ql/720] = [ql/144]$$